

TECE
close to you



**MORE
COMPACT.
MORE
UNIVERSAL.
EASIER.**

The TECE Octa II cistern
for TECEprofil and TECEbox.

NEW



FLUSHING TECHNOLOGY MADE TO MEASURE

With a depth of just 8 cm and a width of 50 cm, TECE Octa II sets new standards. In terms of systematics – as an element in the TECEprofil system. In terms of efficiency – thanks to new components that make installation even quicker and easier. And in terms of design – with the full variety of the TECE flush plate range.

“Flushing technology must be flexible and reliable. Although installed in a small space, nothing is spared – either in terms of technology or design options.”



Proven technology – even better in handling

Out of the box, onto the wall: flushing technology from TECE is that simple. Tried and tested properties and new details help make handling even more reliable. No errors, no readjustment – discover TECE Octa II cistern with the handling upgrade.

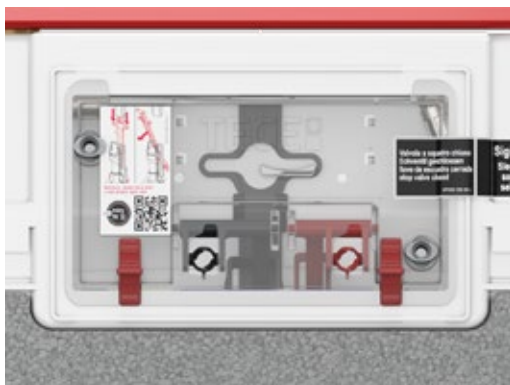

Maximum smartness

The TECE Octa II cistern is pre-assembled and sealed at the factory, which means that it only needs to be opened at the fine installation stage. New features such as the easy fit quick installation for flush plates now make installation even faster and less stressful – avoiding the need for tools in many places.



Minimal space-consumption

With the usual 8 cm depth in the TECEprofil module, TECE Octa II is just 50 cm wide and therefore optimally designed for every common installation scenario. With a filling capacity of 7 litres, it continues to allow immediate flushing – without waiting time.

New!

- 500 mm wide – for every installation scenario
- Compatible with all TECE flush plates
- Can be used with mechanical, electronic and pneumatic actuation
- easy fit tool-free quick assembly for flush plates
- Installation tunnel with “zip” function: shorten without tools
- Quick adapter for the water connection
- Now also available in the TECEprofil toilet module, compatible with the TECEprofil pre-wall system

MAXIMUM FLEXIBILITY

TECE Octa II is the new multi-talent in a small space: for every installation scenario and for every actuation requirement.

Compatible with all flush plates

With TECE Octa II, you can experience the whole world of TECE flush plates: all TECE flush plates – manual, electronic or pneumatic – can be used with the new generation of TECE Octa cisterns. No more either or: with its sophisticated technology, the mechanical flush plate can still be fitted even when a remote control is installed.

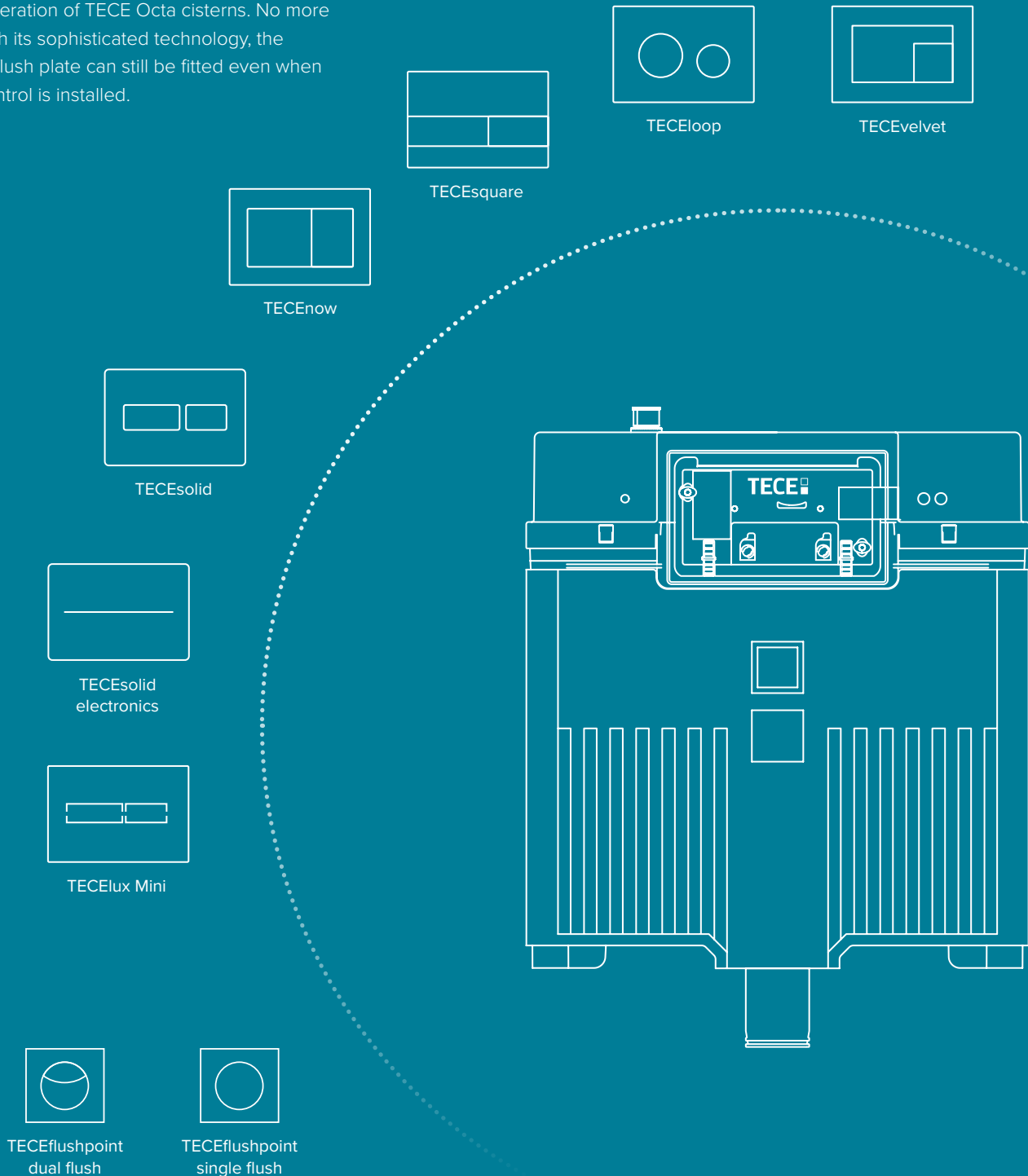

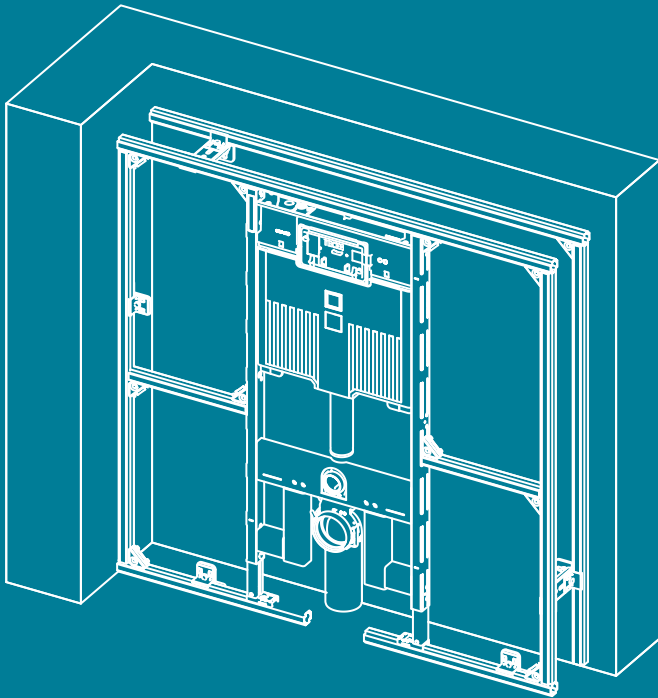

Installation in a TECEprofil pre-wall

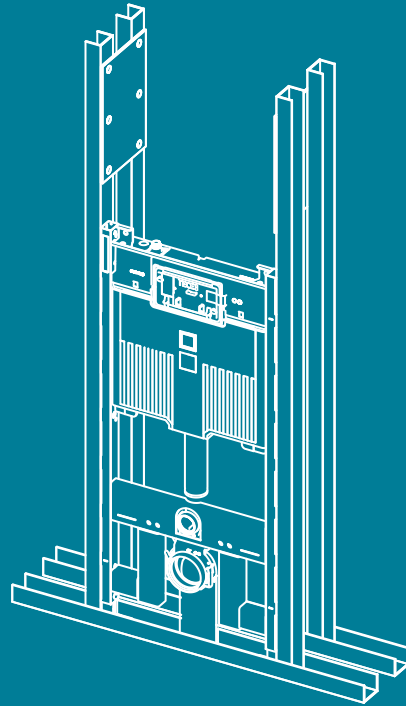

Installation in metal profiles and wooden stud walls

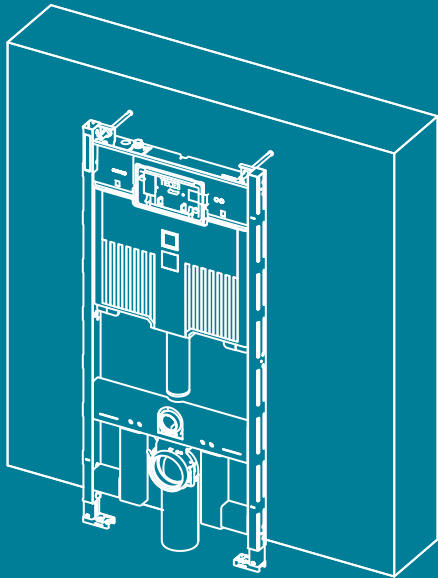

Individual module installation in front of a solid structural shell wall

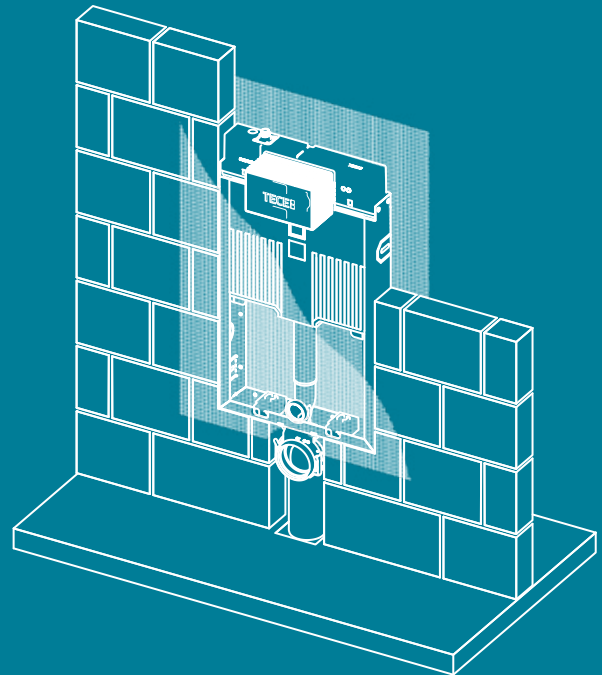

Installation in a masonry pre-wall

Designed for any installation scenario

TECE Octa II is available in the customary TECEbox module for installation in a masonry pre-wall. And now also in the TECEprofil toilet module for flexible use in the TECEprofil pre-wall system, in metal or wooden stud walls and for installation in front of a solid or plasterboard wall.

ALL INSTALLATION UPGRADES AT A GLANCE

new: 500 mm



Quickly connected – without sealing

The cistern's new water connection has a 1/2" outer thread and is compatible with quick adapters. Time-consuming sealing? Not any more.

Installation made easy

Thanks to easy fit quick installation for flush plates, you save 60 % working time – and a lot of worry.

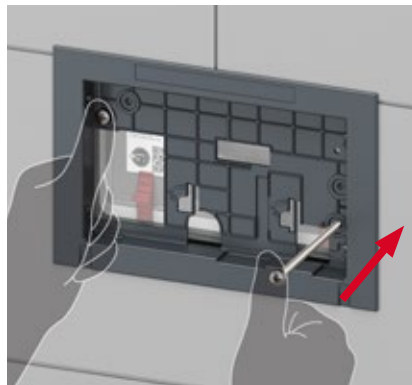

Up and down.

The TECEprofil toilet module is height-adjustable by up to 30 cm – for flexible adaptation to a wide range of building scenarios.



Discover the new TECE Octa II cistern:
in our new feature video at www.tece.com
or on the TECE YouTube channel.



m total width



Fits!

With a width of 500 mm and a depth of 80 mm, the TECEprofil toilet module with Octa II cistern is compact and space-saving for any installation scenario.



Removed with a "zip"

No sharp knife, no sharp breaking edge: with the new TECE Octa II cistern, the polystyrene bare-wall protection sits in an installation tunnel with a "zip" function. The wall is plastered and tiled up to the installation tunnel. Afterwards, the bare-wall protection is simply removed. The installation tunnel can simply be pulled off at the required depth with a "zip". Dangerous freehand cuts when shortening with a cutter knife are unnecessary here.

Bathroom design made easy

The TECE Octa II cistern is fully pre-equipped in the TECEprofil toilet module for use in the TECEprofil pre-wall system. Simple installation is achieved using corner joints, which are inserted into the slots in the module frame and connected to the supporting structure.



Retained features:

- Installation depth of just 8cm, ideal for installing in dry walls
- Sealed tank, doesn't have to be opened in shell construction
- Bendable, easily removable drain valve
- Easy flush volume adjustment
- Throttle set for flushing pressure adjustment

INSTALL THE FLUSH PLATE – FASTER THAN EVER!

with easy fit, installing the flush plate can be done without stress and in one go. No need for readjusting or measuring.

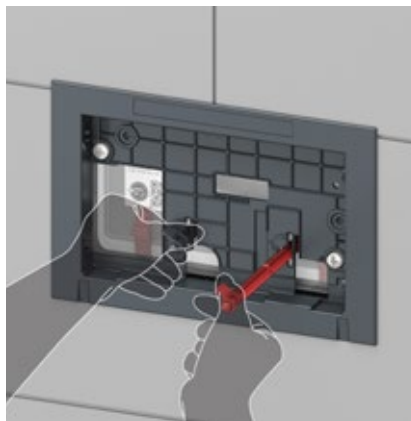
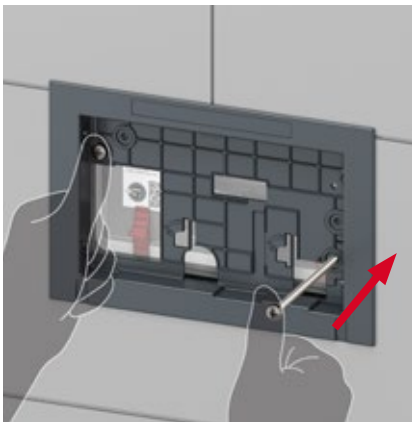

Insert the screws, push them through and tighten them with just a few turns – the attachment frame is already firmly seated on the splash guard. Now simply insert the actuation rods and fix them in place with a 45 degree turn. This not only saves nerves, but also around two thirds of the time!

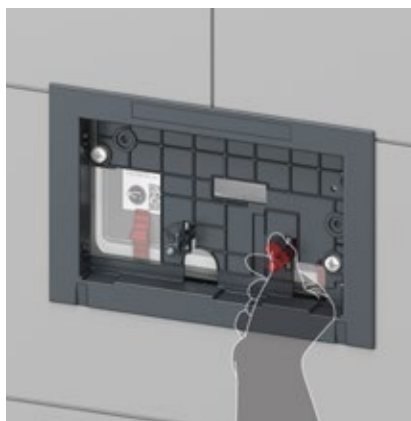

"All the plates fit. Every time!"



“In 2021, we will be adding a whole range of upgrades to our flushing technology. Many of these have come from your suggestions or from conversations with you. Time to say thank you! And as ever, the same applies to this upgrade: full compatibility throughout the whole range.”

Andre Meiermann, Product Manager Sanitary Systems

Universally compatible!

All TECE flush plates are compatible with the universal cistern from TECE - whatever the series, whatever the year! We also guarantee this for cisterns and flush plates with and without easy fit.

Combinations with and without easy fit. Making assembly a success!

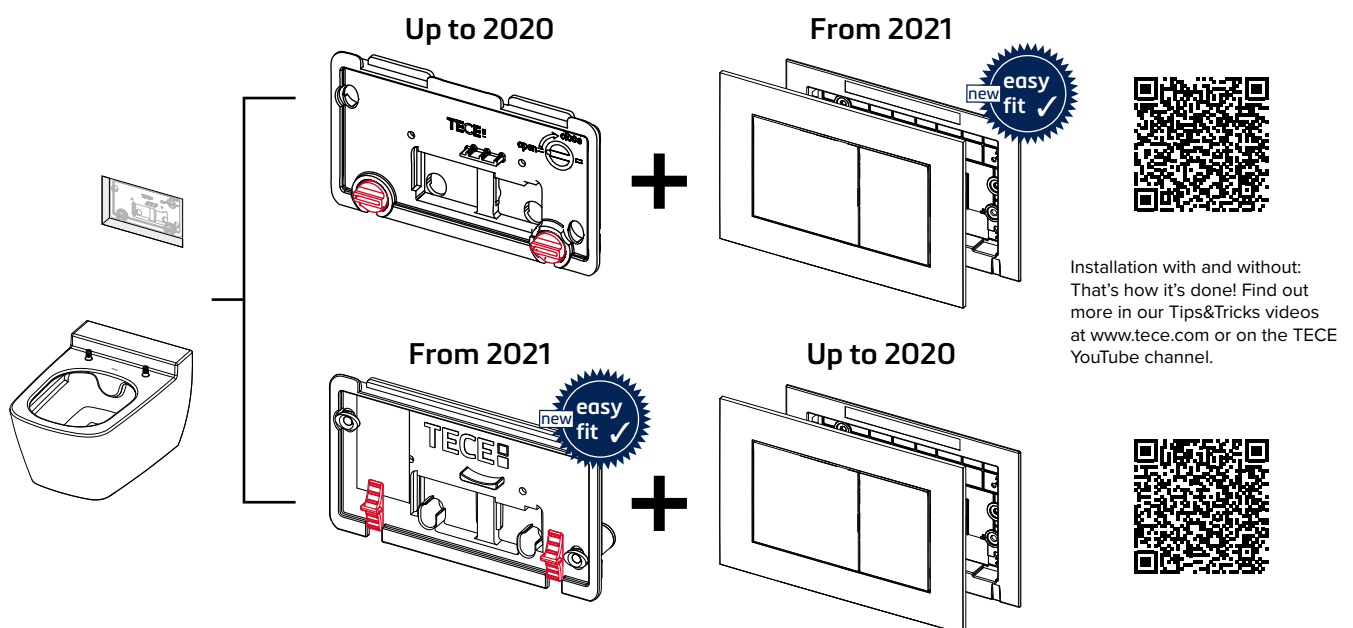

A HEAD START IN THE SYSTEM

Out of the box, ready to go: In the TECEprofil module, the TECE Octa II cistern is ready for quick installation in dry-wall construction.



TECEprofil angle bracket, corner joint and section tube – with just three basic components from TECEprofil, a complete supporting structure can be achieved in next to no time. This allows different room layouts to be quickly realised and standards and regulations to be reliably complied with. Simply and safely.



Prefabricated modules, e.g. here for washstand and toilet, enable simple and structurally safe installation of half-height or room-height front or partition walls.

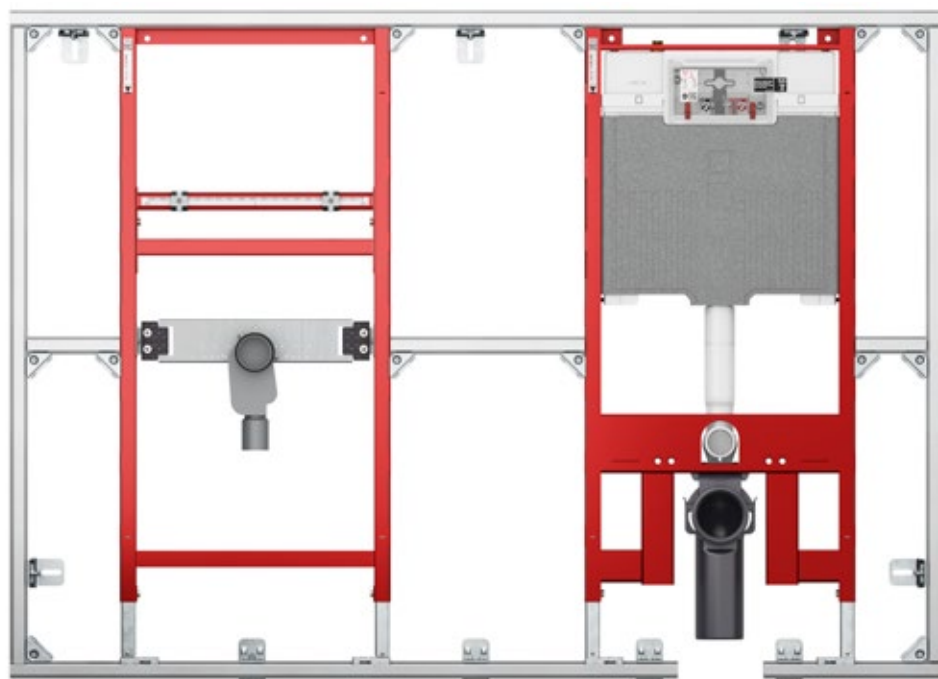

The TECEprofil family

In the TECEprofil range, all common sanitary installations are prepared as pre-assembled modules for dry-wall construction, but also for installation in a TECEprofil pre-wall, in front of a solid or plasterboard wall or in a metal or wooden stud wall. Here is a selection of our most popular models:



- 1 Toilet module with Octa II cistern, 8 cm
- 2 Toilet Geronto module with Uni cistern
- 3 Urinal module with valve housing U 2
- 4 Washstand module with flush-mounted odour trap
- 5 Bidet module for wall-hanging-mounted bidet,
- 6 Bath/shower module for flush-mounted and wall-mounted fittings
- 7 Attachment plate for safety support arms and support systems

Also perfect in brick-wall construction: TECEbox

For quick and easy installation in brick-wall construction, the TECE Octa II cistern is still available in the TECEbox module for standing and wall-hanging toilets. The TECEbox family also offers practical modules for mounting washstands and bidets.

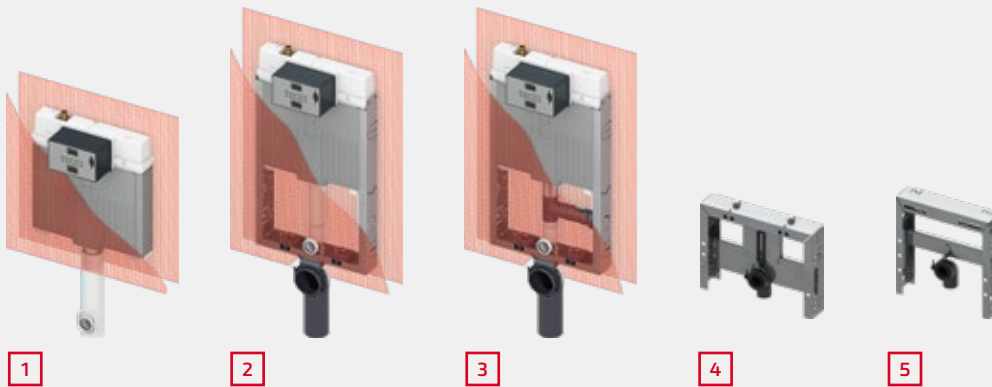

- 1 II cistern, 8 cm, for floor-standing toilet, with reinforcement fabric
- 2 Toilet module with Octa II cistern, 8 cm for wall-hanging toilet
- 3 Toilet module with Octa II cistern, 8 cm for wall-hanging toilet, with connection for odour extraction
- 4 Washstand module
- 5 Bidet module

INNER VALUES THAT COUNT

Perfect for every installation scenario: Despite its slimline installation depth of just 8 cm, the TECE Octa cistern makes no compromises when it comes to flushing performance.

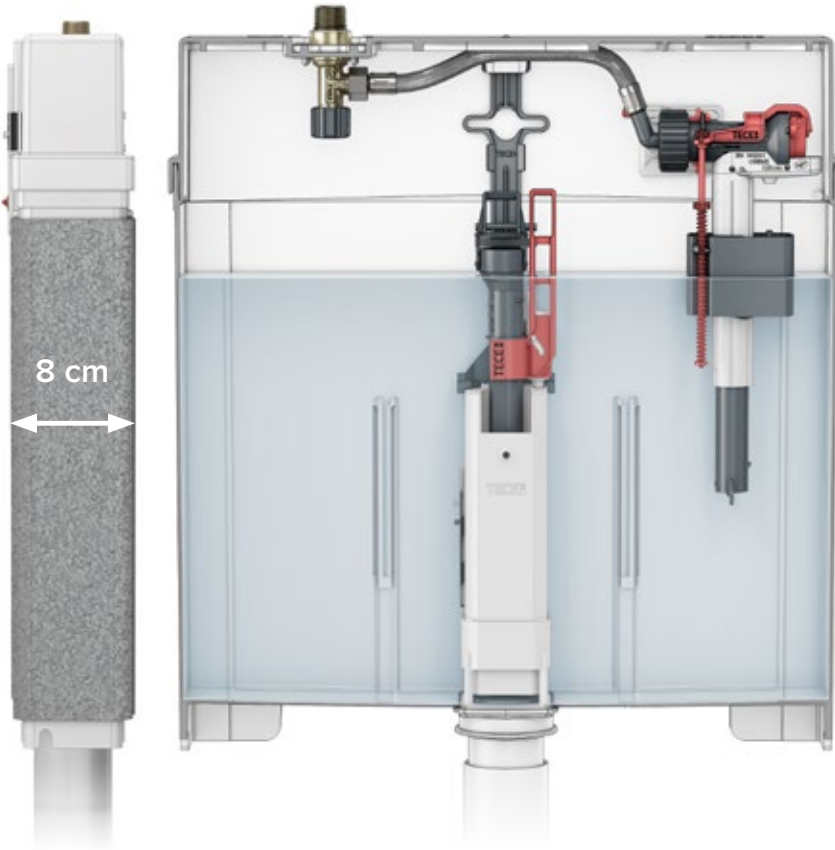

Slim installation, high performance

Compared to the TECE Uni cistern, the TECE Octa II cistern is 5 cm slimmer and therefore perfectly suited for installation in partition walls. With a water volume of 7 litres, it offers sufficient reserves for immediate flushing at all times.



Cleverly designed

Optimal handling despite lower depth: If the drain valve has to be removed during an inspection, it can simply be moved to the top - this making it easy to remove from even narrower cisterns with zero problems.

Nothing spared

Big technology in a little space: Despite the smaller installation depth, all the technical highlights of the Uni cistern are also built into the extra-flat TECE Octa cistern range.

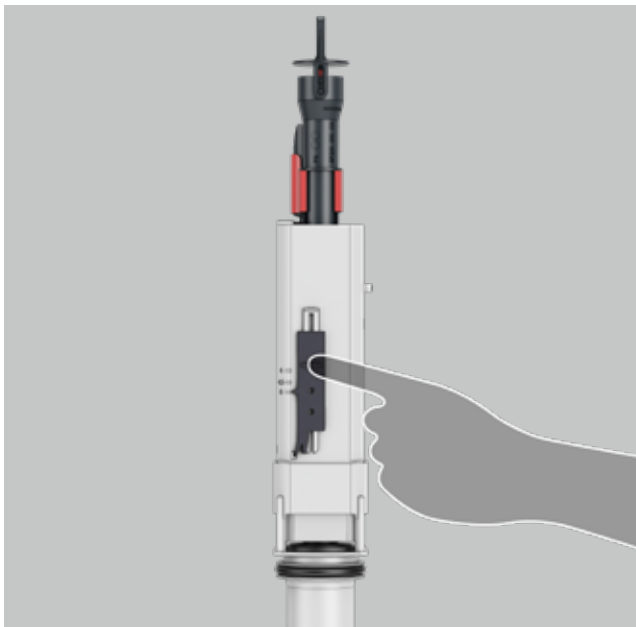

Save water

A slider on the drain valve makes it easy to change the large flush volume from 6 to 4.5 litres. The small flush volume remains constant at 3 litres. Optionally, 4/2 litres can also be set.

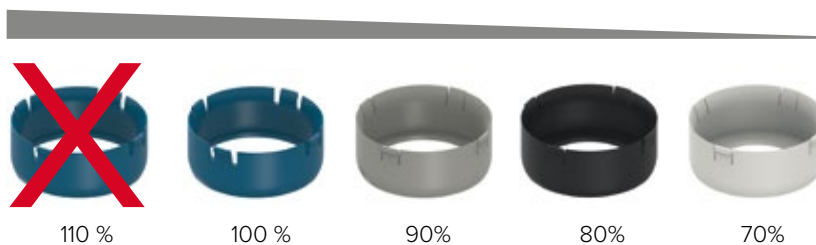

Customised flushing pressure

With the matching throttle set, the flush pressure can be reduced down to 70 %. Removing the throttle ring also lets you increase the flush pressure to 110 %.



The TECE Octa II cistern comes pre-assembled and sealed. This means in the shell construction phase it just has to be connected to the water line - you only need to open it during fine installation.

OPERATION WITHOUT LIMITS

Requirements for the cistern are numerous: also in terms of use. That's why the TECE Octa II cistern sets no limits on the choice of actuation, either visually or functionally.



Attractive variety

All mechanical, electronic and pneumatic actuators from the extensive TECE flush plate range can be combined with TECE Octa II. Setting design accents has never been so easy!



Electronics – elegance with brains

Whether you choose TECElux Mini, the flat glass actuation with illuminated function areas, or TECEsolid electronics with the latest ToF sensor and made of 2 mm thick stainless steel: TECE flush electronics add hygiene for private and public areas.

Hygienic and safe

The robust stainless steel TECEsolid electronic toilet flush plate measures and interprets movements in space and time thanks to ToF sensors. If a person steps into the detection area, the sensors light up. If a hand comes within about two centimetres, the flush is triggered without contact. False triggers are a thing of the past. If a flush is forgotten, the programme automatically triggers a safety flush - for added hygiene in public toilets.

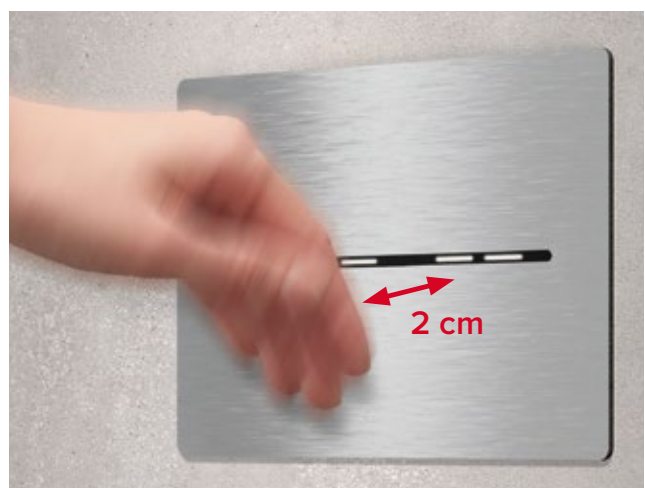

Pneumatic – no more either/or



For barrier-free toilets and public areas, TECE Octa II can also be used with pneumatic actuation. The conventional actuation can be retained.

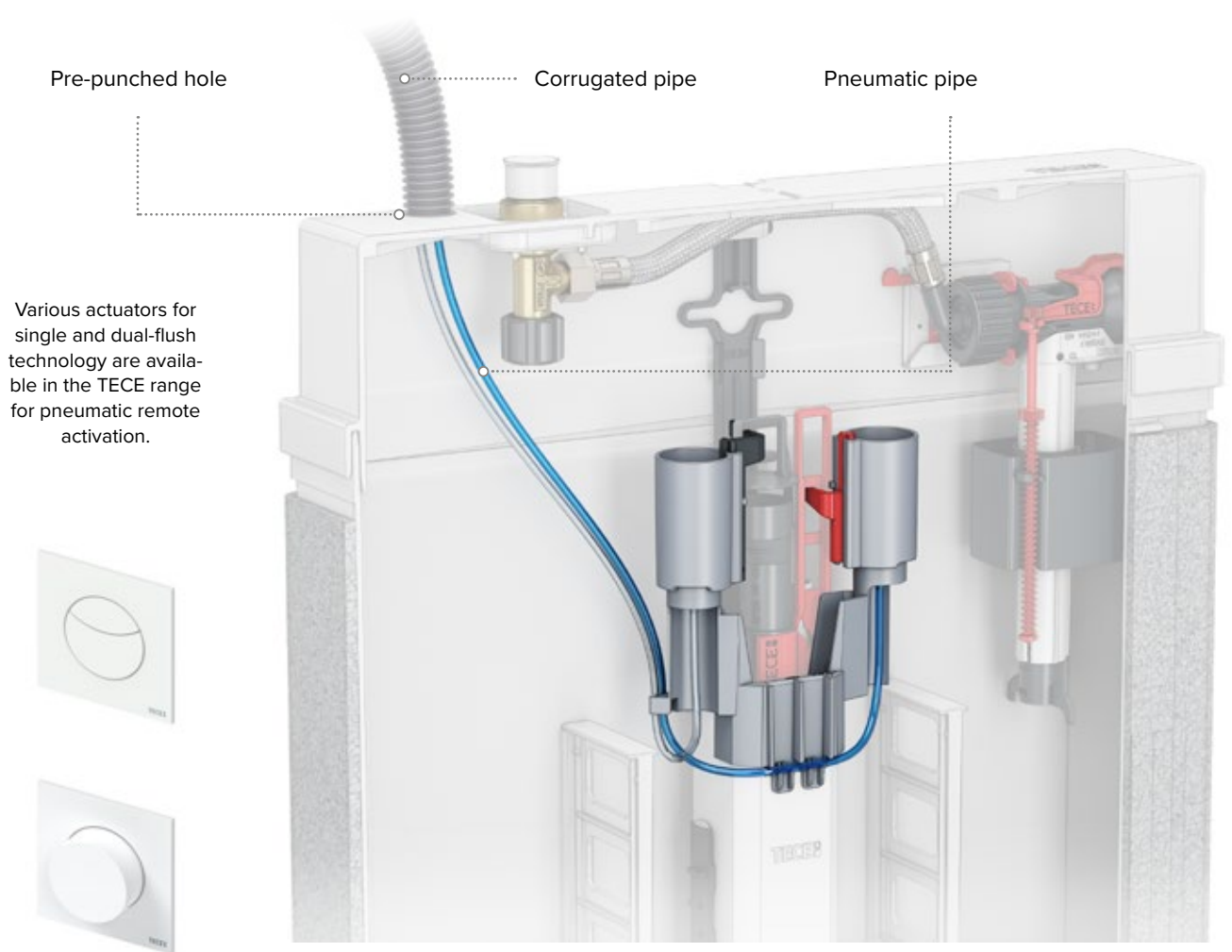

Simple conversion

The well designed positioning of the pneumatic pipe inside the cistern allows for pneumatic remote actuation to be used also in combination with a manual TECE flush plate or an inspection panel. The TECE Octa II cistern can therefore be easily equipped with an additional flush button “at the click of a mouse”.

Always compatible

The TECE Octa II cistern is compatible with the range of more than 200 TECE flush plates. This means that there are not only no restrictions on design diversity – but also on flexibility. Because for renovation and modernisation work, they can be interchanged regardless of series and year. Even after decades.



TECEvelvet



TECEloop



TECESquare



TECESolid

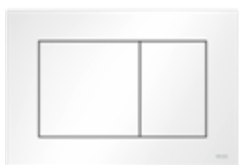

TECEnow



TECElux Mini



TECESolid
electronics



Our new item numbers (valid from 09/2021):

TECEprofil	Description	Old item no.*	New item no.
	TECEprofil toilet module with Octa II cistern, 8 cm, installation height 1120 mm	9300040 →	9300500
	TECEprofil toilet module with Octa II cistern, 8 cm, with connection for odour extraction, installation height 1120 mm	Variant was not previously available	9300501
	TECEprofil toilet module with Octa II cistern, 8 cm, installation height 1120 mm, includes sound insulation set	9300065 →	9300502

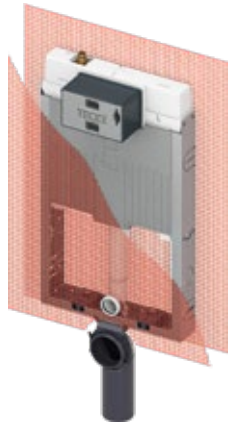
TECEbox	Description	Old item no.*	New item no.
	TECEbox Octa II cistern, 8 cm, for standing toilet, with reinforcement fabric, installation height 1075 mm	9370007 →	9370500
	TECEbox toilet module with Octa II cistern, 8 cm, for wall-hanging toilet, installation height 1075 mm	9370008 →	9370501
	TECEbox toilet module with Octa II cistern, 8 cm, for wall-hanging toilet with connection for odour extraction, installation height 1075 mm	9370041 →	9370502
	TECEbox Octa II cistern, 8 cm, for floor-standing toilet, installation height 1075 mm	9370038 →	9370504

* Change due in September 2021

For more information visit
www.tece.com

TECE GmbH
 T +49 25 72/9 28-999
international-business@tece.de
www.tece.com